

46

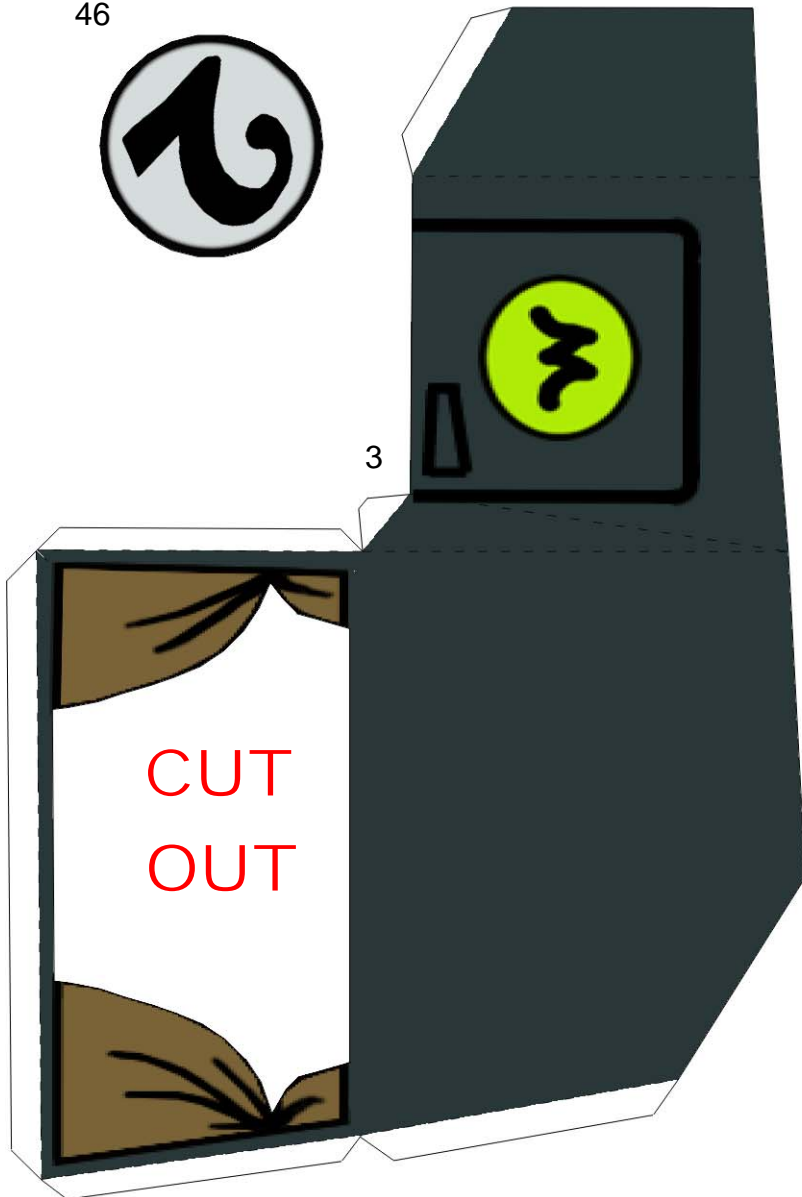

CUT
OUT

3

17A

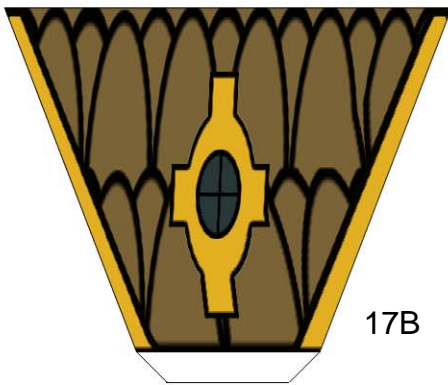
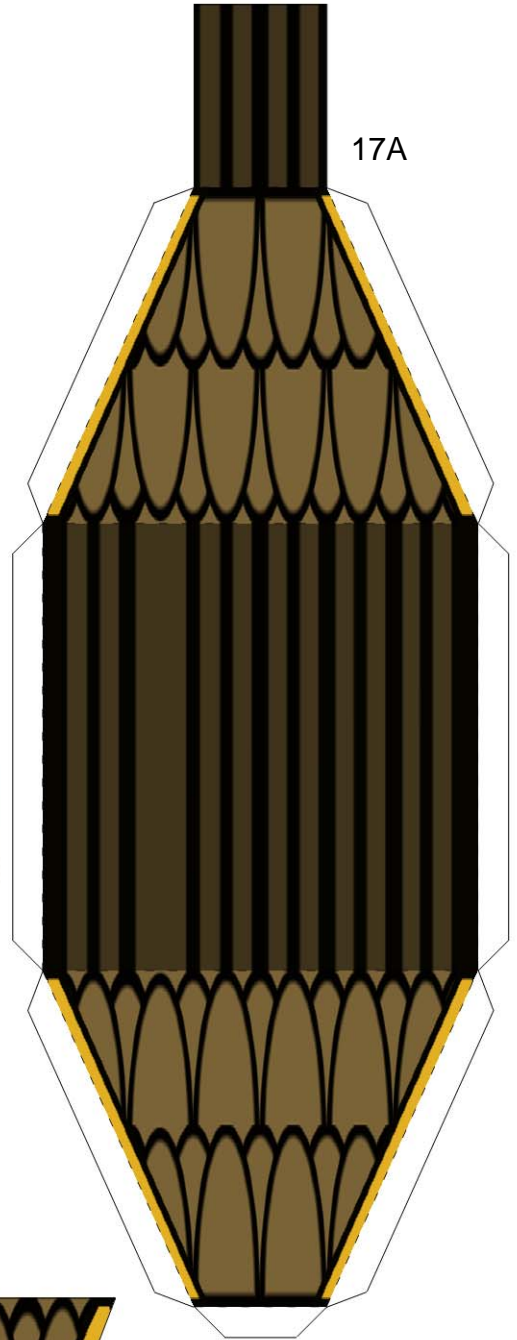

17B

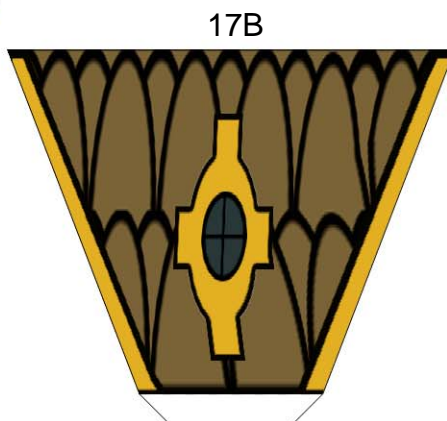

17B

No.2 - The Creepy Coupe

p1

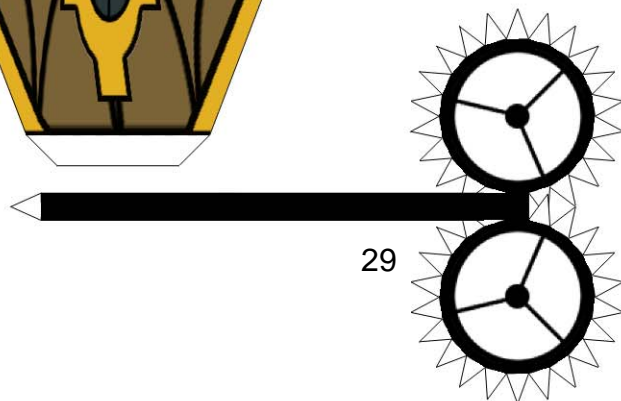

29

47

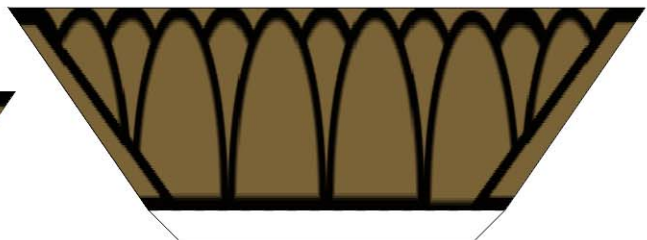
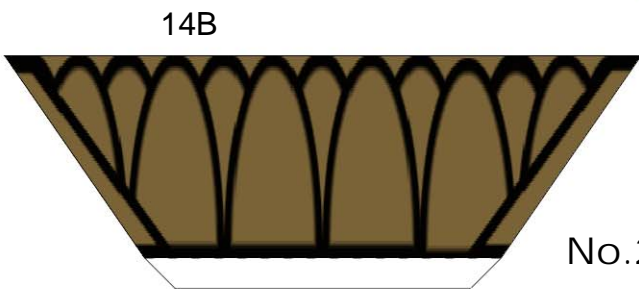
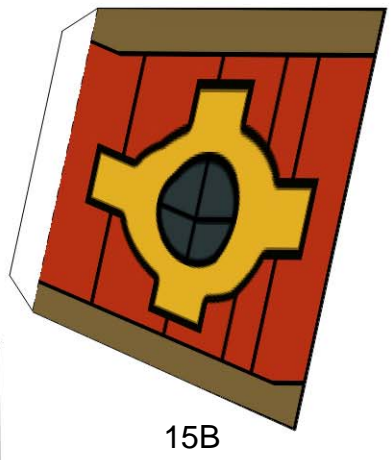
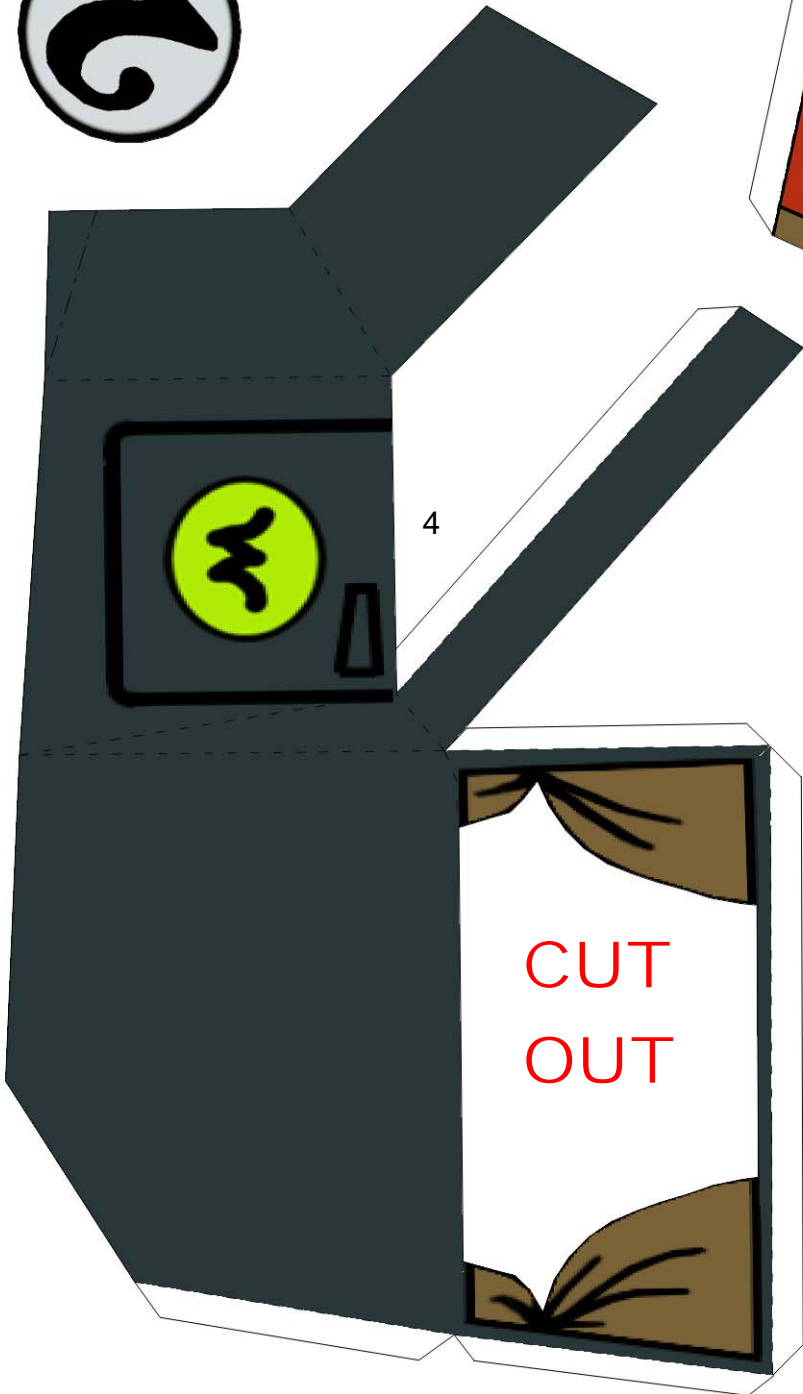

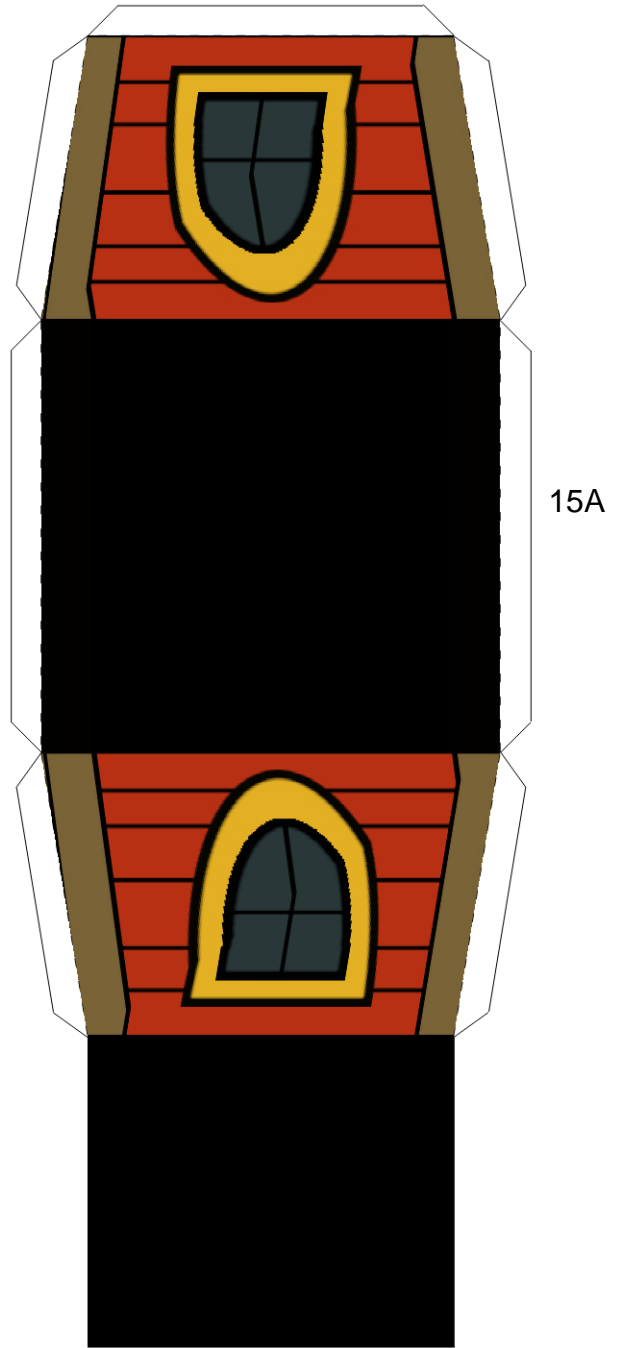

No.2 - The Creepy Coupe
p3

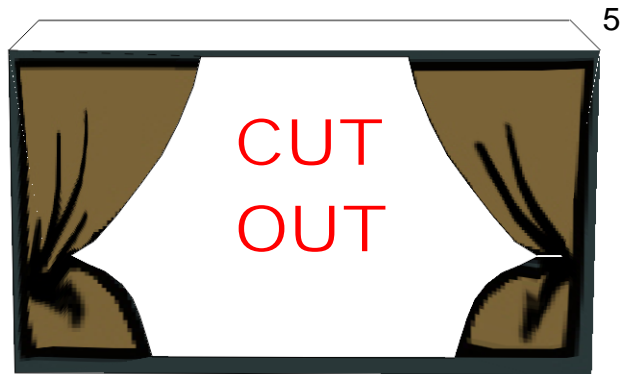
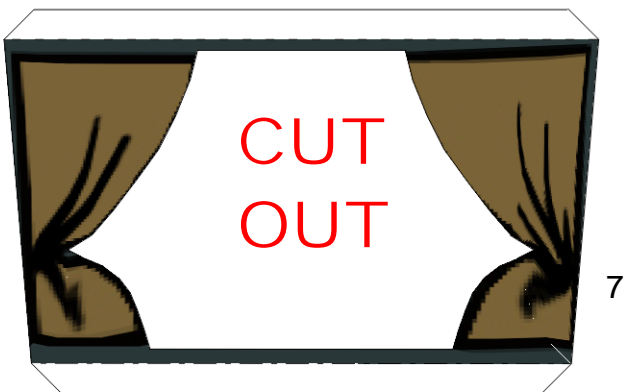

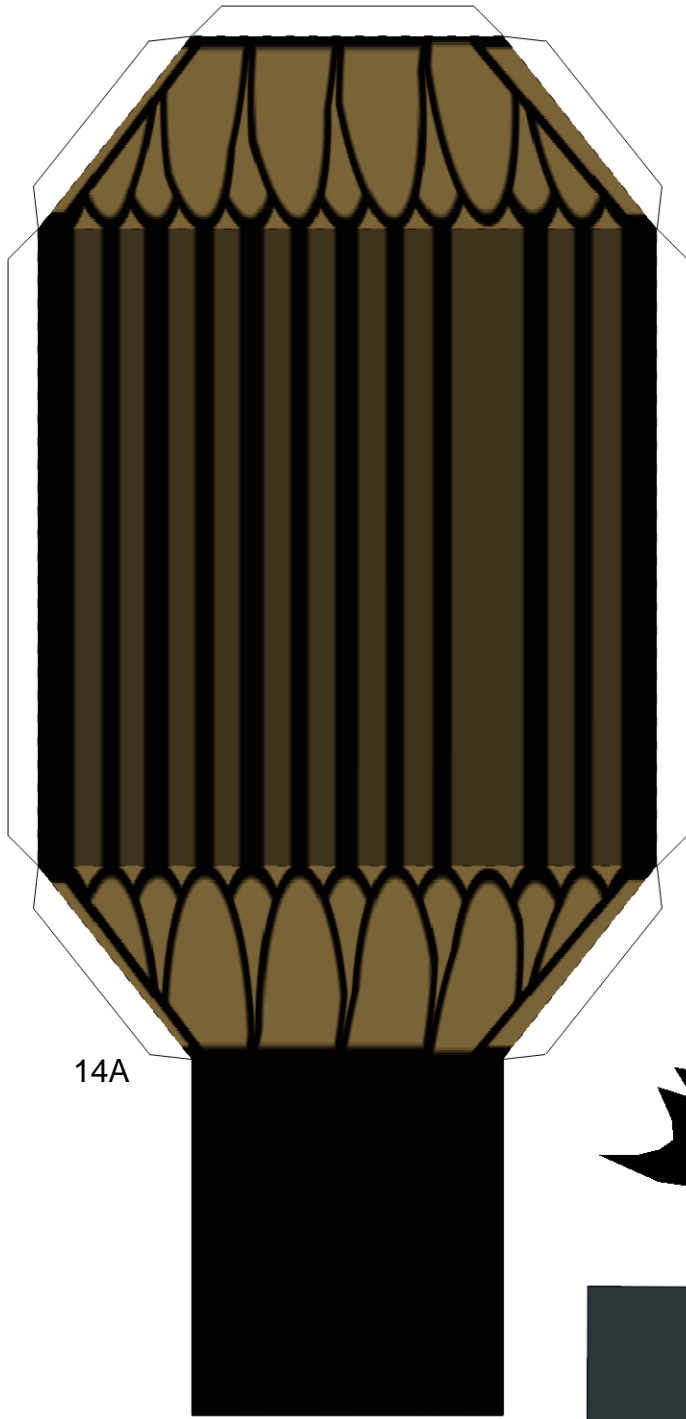

14A

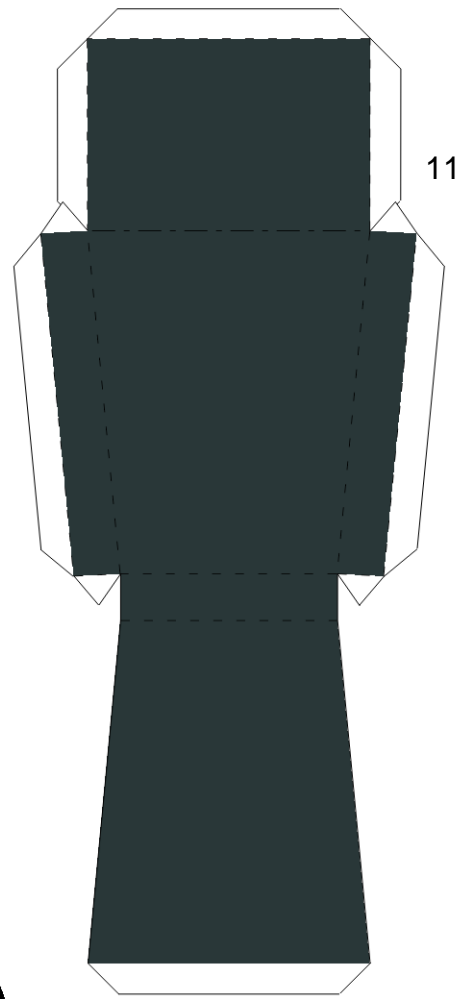

11



48A



48B

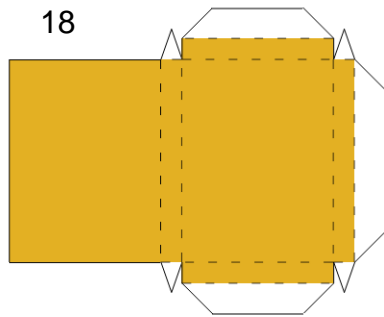

18



6

No.2 - The Creepy Coupe

p4

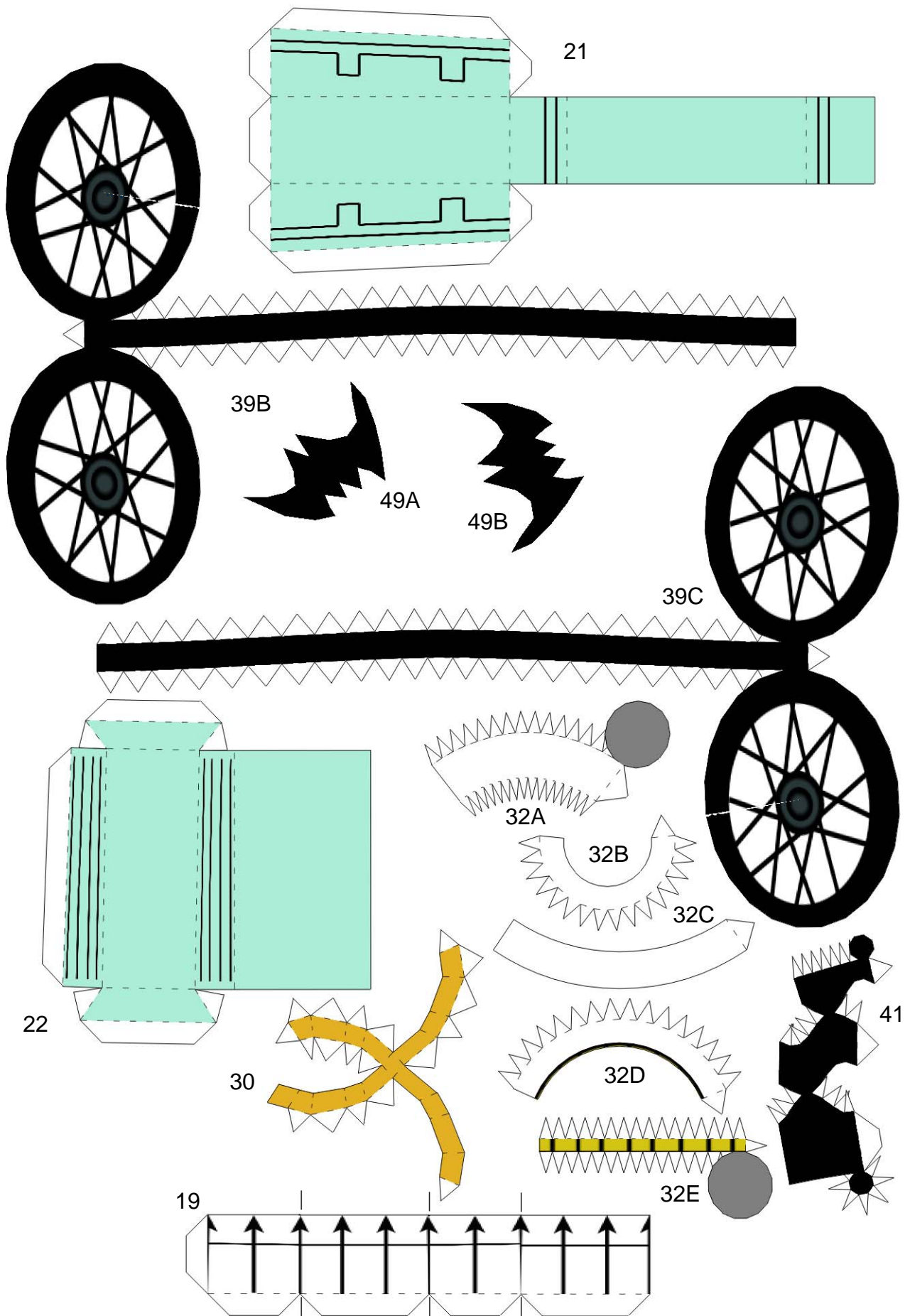

No.2 - The Creepy Coupep5

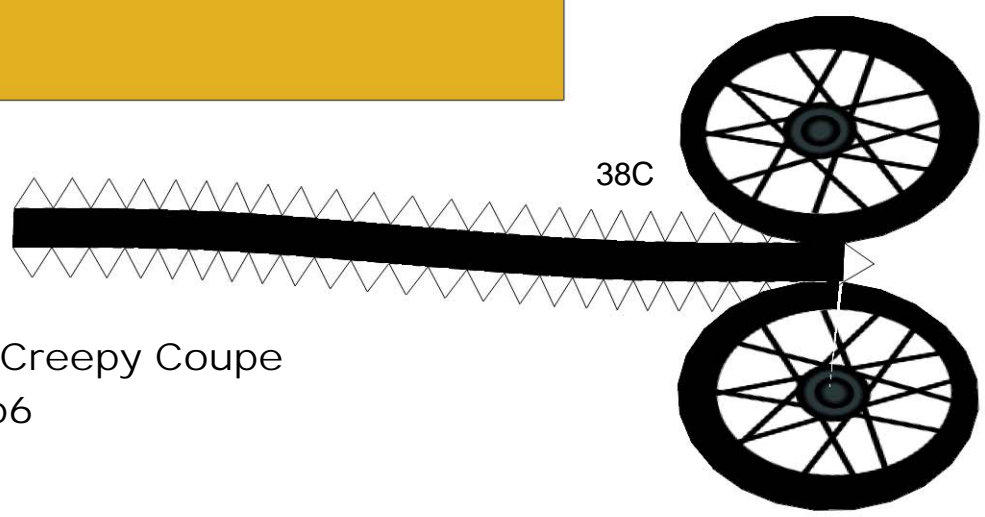
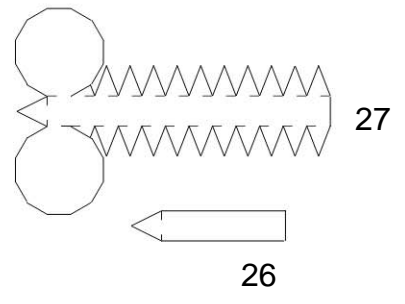
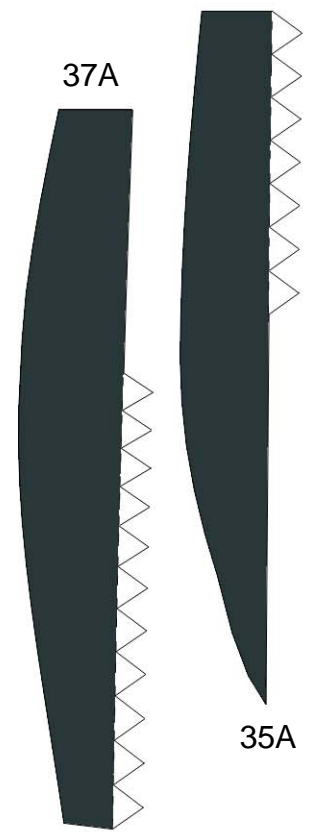
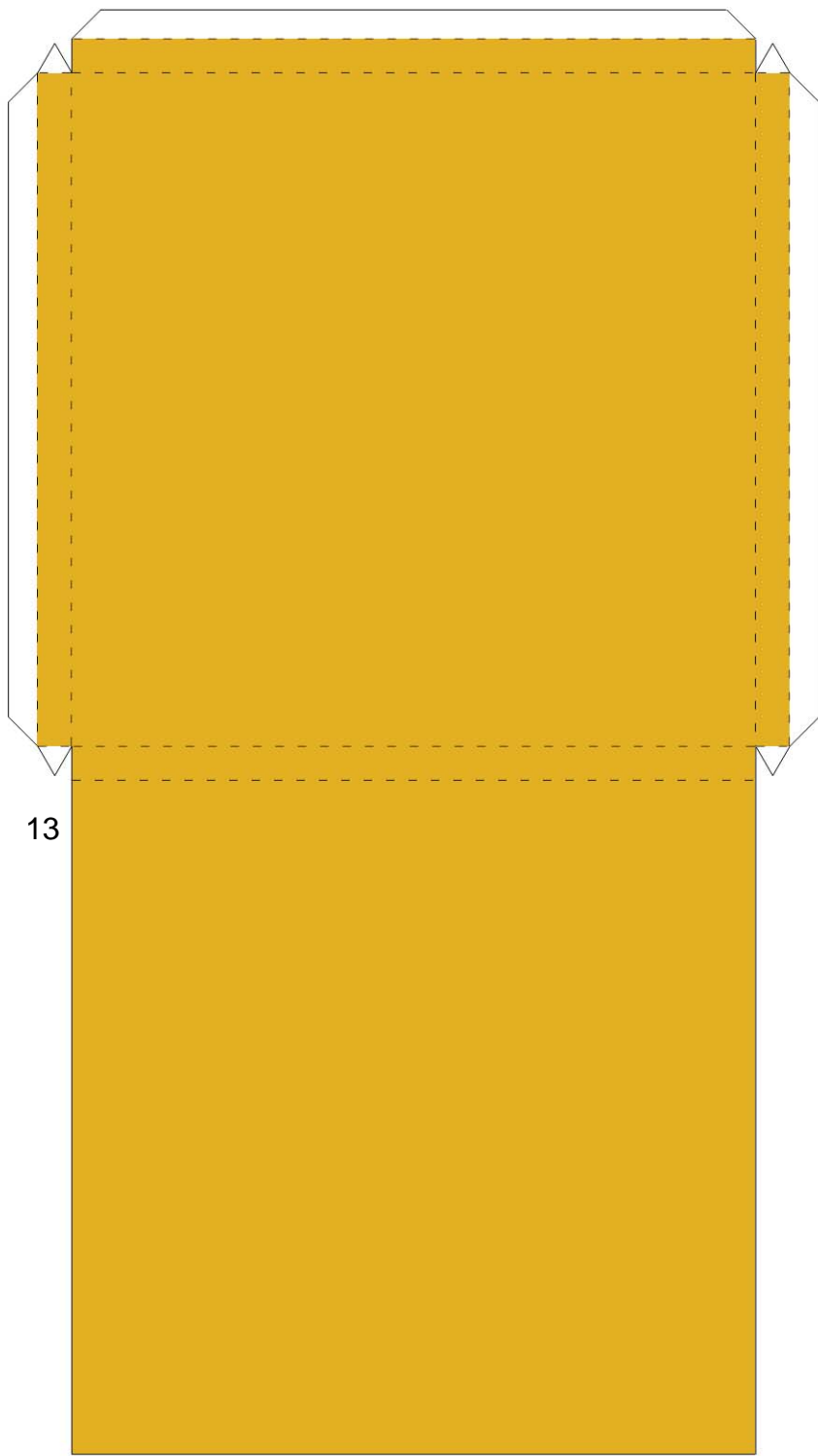

No.2 - The Creepy Coupe
p6

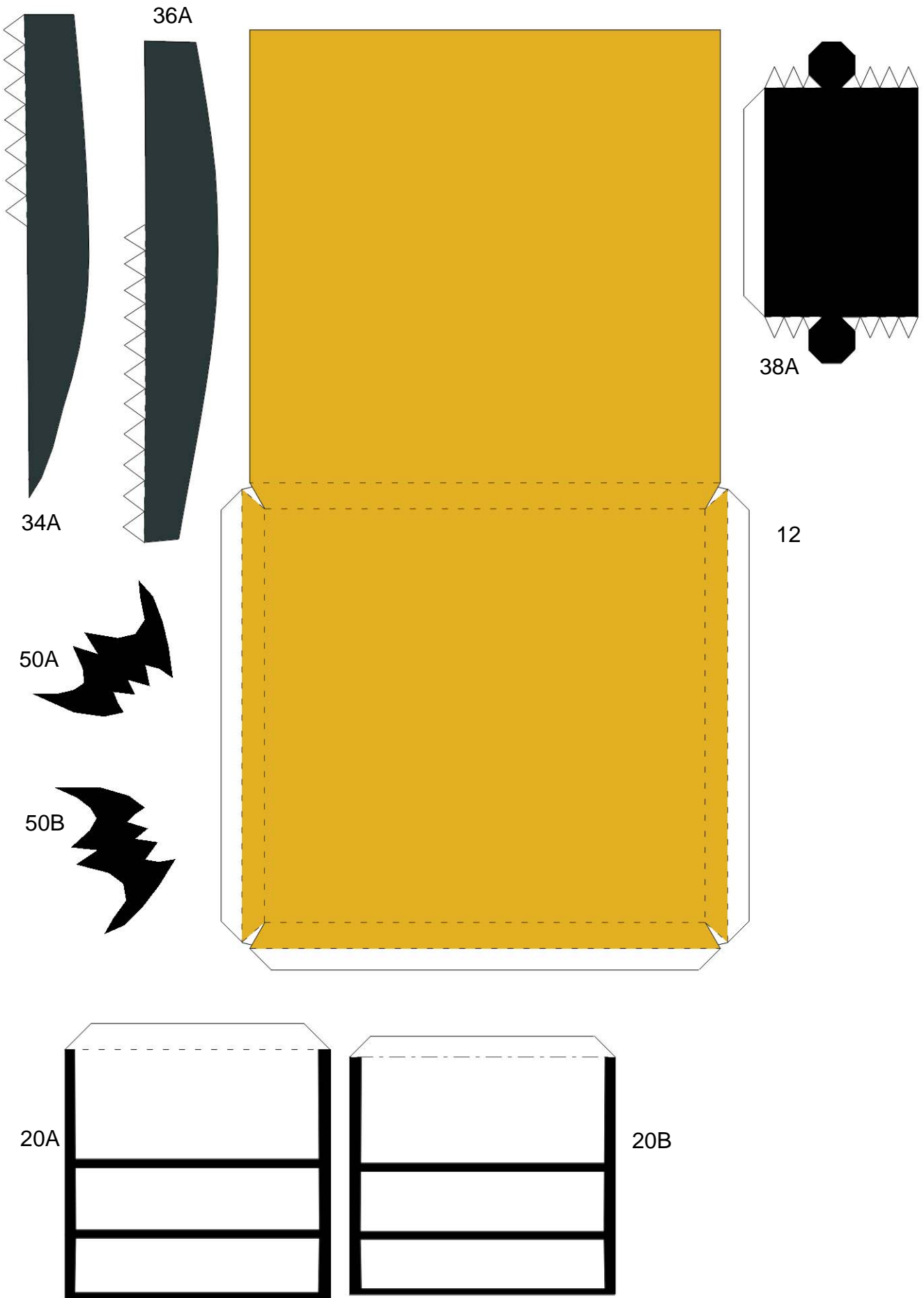

No.2 - The Creepy Coupe p7

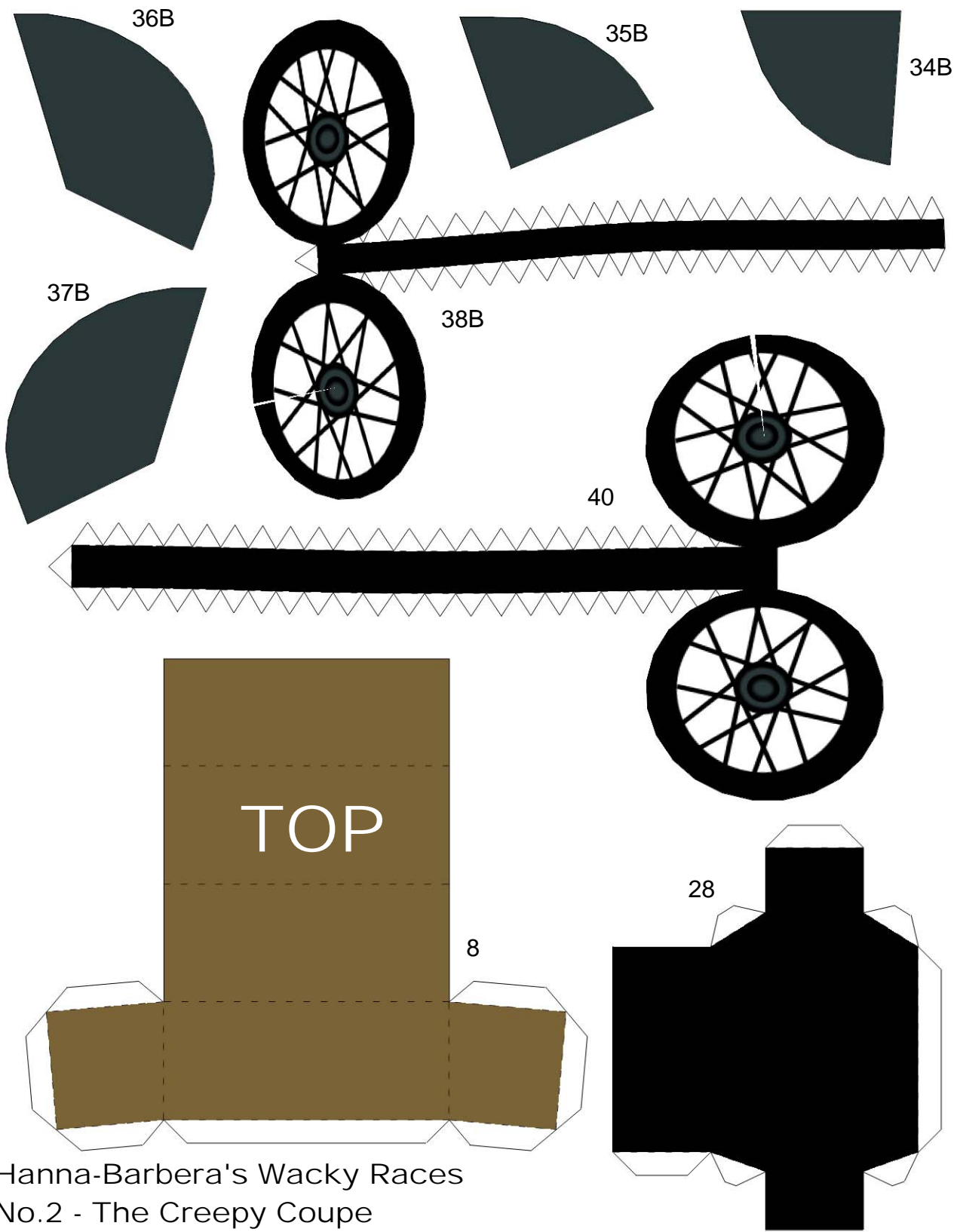

Hanna-Barbera's Wacky Races

No.2 - The Creepy Coupe

Wacky Racers © Hanna-Barbera

Papercraft Pattern ©2005

Papercraft By The Webdude

NO COMMERCIAL USE IN ANY FORMAT p8

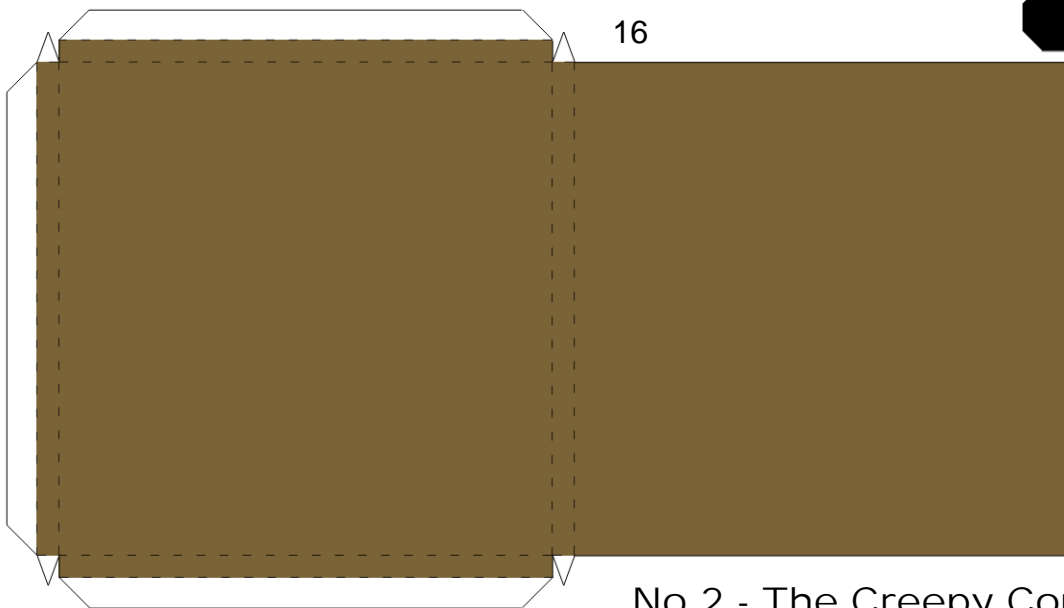
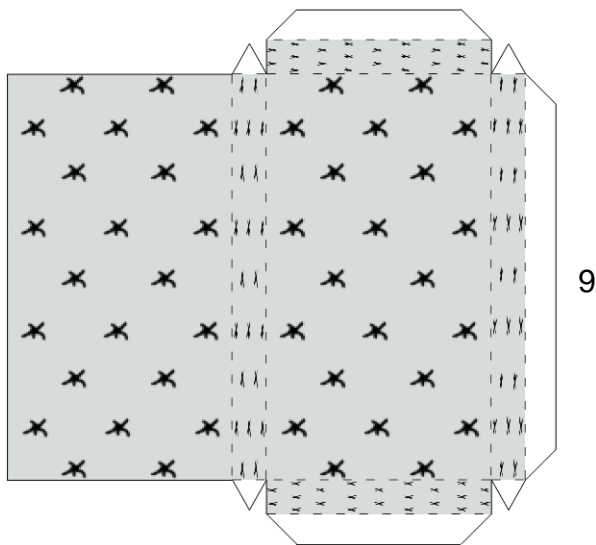
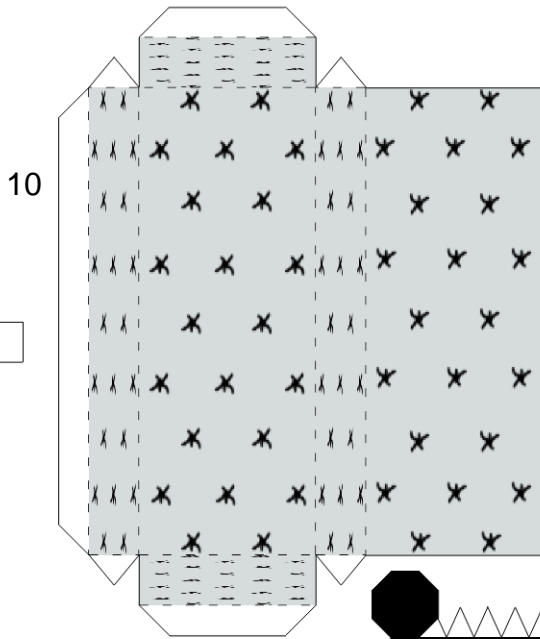
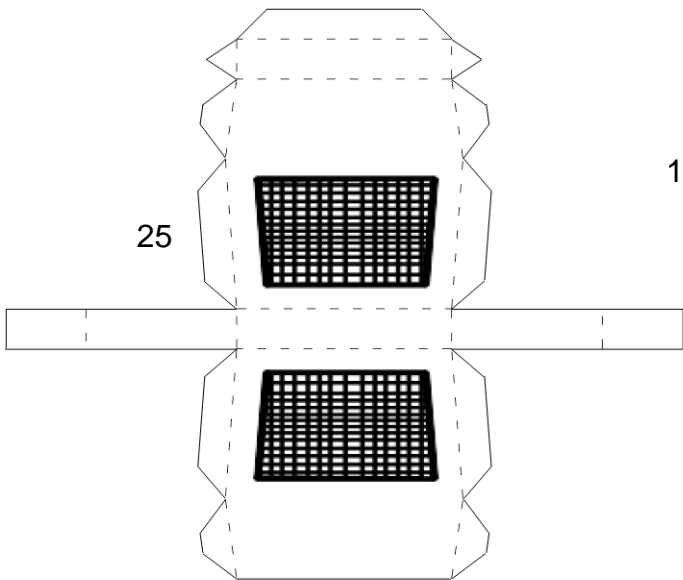

No.2 - The Creepy Coupe
p9

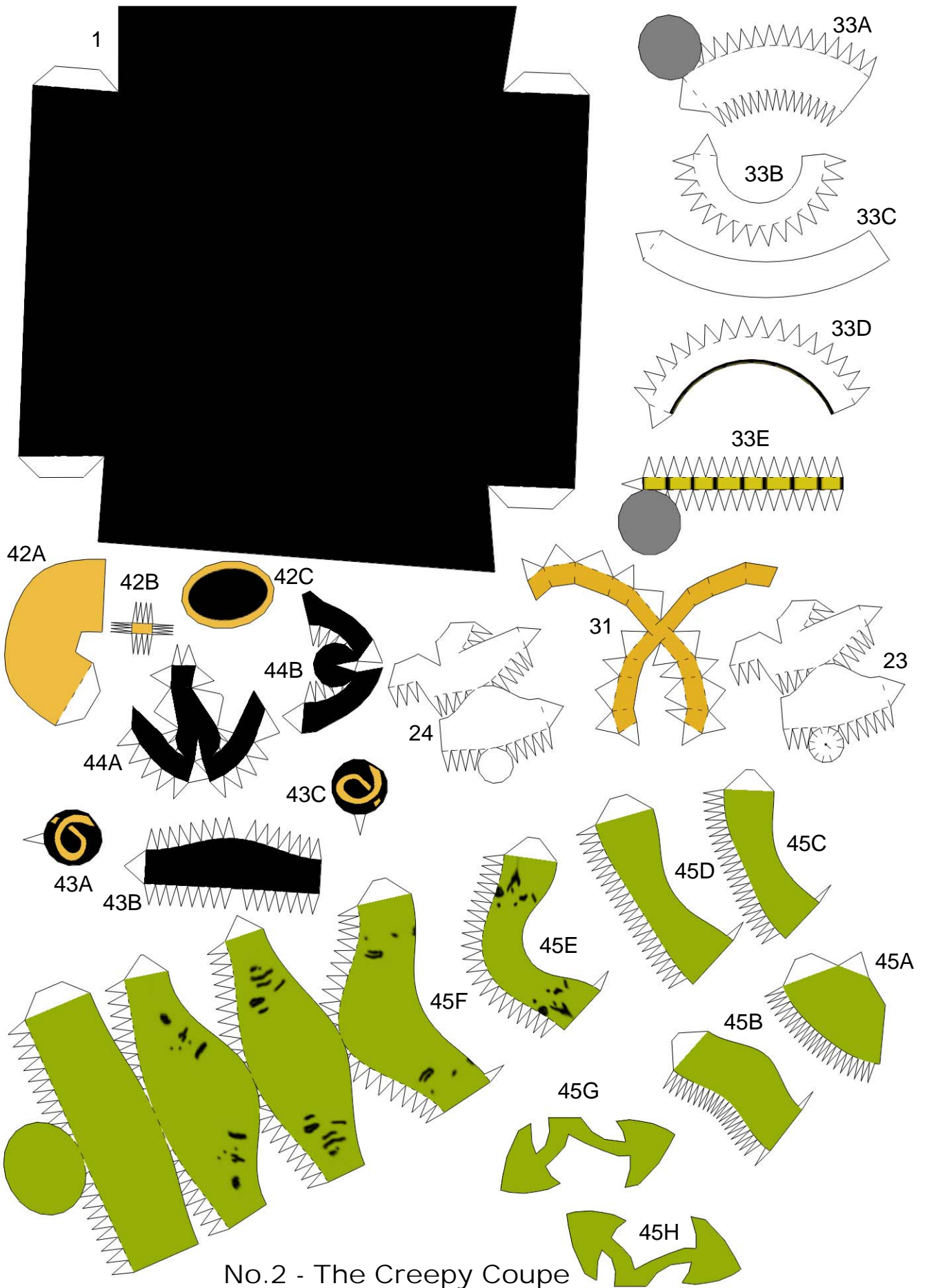

No.2 - The Creepy Coupe
p10